

МОЩНЫЙ СВЕТОДИОД ARPL-37W-TFA-1919-90

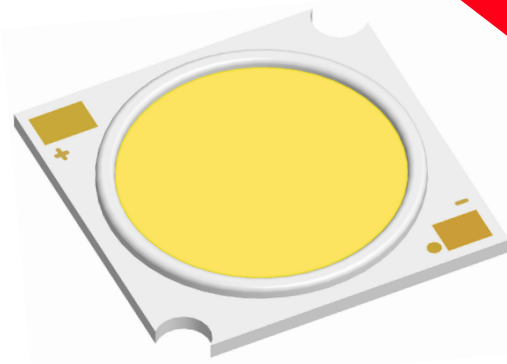

FEATURES

- 4000K, CRI90, Light effect 127lm/w.
- CRI 70, 80, 90.
- High density LED light source.
- Smooth cooling channel.
- Color gamut distribution of products in compliance with Energy Star / ANSI standards.
- Standard 2SDCM, 3SDCM and 5SDCM color tolerance.
- DC low or high voltage drive.
- Positive company LOGO and product series.
- Comply with RoHS standards.
- More energy efficient than incandescent, halogen and fluorescent lamps.

SUPERIORITY

- High brightness and light efficiency.
- High color saturation.
- Easy to use with solar and wind energy saving systems.
- Enhanced optical control.
- Greatly reduce the thermal resistance of the light source, improve the weather resistance quality of the light source.
- Reduce the cost of use.
- Reduce maintenance costs.
- No environmental disposal issues.

MECHANICAL DIMENSION

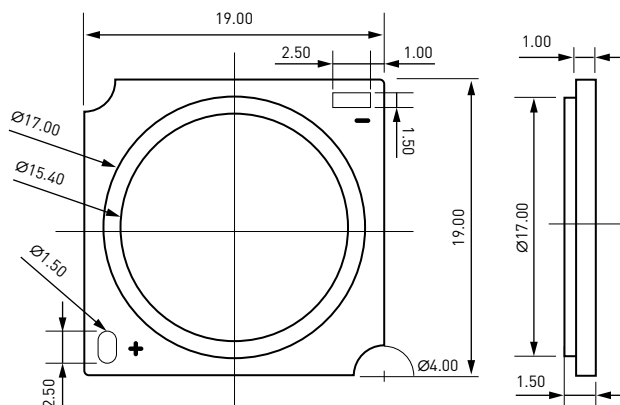

Notes:

1. All dimension tolerance is $\pm 0.15\text{mm}$ unless otherwise noted.
2. The Tc Test Point of the Product is at The N Pad.

ELECTRO-OPTICAL CHARACTERISTICS AT $T_j=85^\circ\text{C}$

Part Number	Typical Power (W)	Nominal CCT (K)	CRI	Pulsed Flux (lm)		Typical Voltage (V)	Nominal Current (mA)	Typical Efficacy (lm/W)
				min	typ			
ARPL-37W-TFA-1919-Warm3000-90		3000		4271	4649			118
ARPL-37W-TFA-1919-Day4000-90	37.8	4000	90	4628	5006	35	1080	127
ARPL-37W-TFA-1919-White6500-90		6500		4539	4917			125

1. Color temperature is defined according to ANSI C78.377-2015 standard.
2. The light source is tested with a DC power supply. Fix the light source on the radiator first and then start the test when the junction temperature $T_j = 25^\circ\text{C}$. The test parameters in actual use depend on the heat dissipation design of the luminaire and the ambient temperature of the actual test.
3. Typical test parameters are for reference only.
4. The allowable tolerance of our company for luminous flux is $\pm 7\%$, the allowable tolerance of voltage is $\pm 2\%$, and the allowable tolerance of Ra is clearly within $+2$.
5. The test current provided in the list is for reference only.

ELECTRICAL CHARACTERISTICS

Part Number	Drive Current (mA)	Forward Voltage Pulsed, $T_j=85^\circ\text{C}$ (V)			Typical Coefficient Of Forward Voltage $\Delta V_f/\Delta T_j$ (mV/ $^\circ\text{C}$)	Typical Thermal Resistance Junction to Case Rj-c ($^\circ\text{C}/\text{W}$)
		min	typ	max		
ARPL-37W-TFA-1919-90	1080	33.6	35.4	37.2	-16	0.29

1. Color temperature is defined according to ANSI C78.377-2015 standard.
2. The light source is tested with a DC power supply. Fix the light source on the radiator first and then start the test when the junction temperature $T_j = 25^\circ\text{C}$. The test parameters in actual use depend on the heat dissipation design of the luminaire and the ambient temperature of the actual test.
3. Typical test parameters are for reference only.
4. The allowable tolerance of our company for luminous flux is $\pm 7\%$, the allowable tolerance of voltage is $\pm 2\%$, and the allowable tolerance of Ra is clearly within $+2$.
5. The test current provided in the list is for reference only.

ABSOLUTE MAXIMUM RATINGS

Parameter	Maximum Rating
LED Junction Temperature (Tj)	125
Storage Temperature	-35... +120
Operating Temperature	-30... +105
Soldering Temperature	350 $^\circ\text{C}$/3-5S
Electrostatic Discharge (HBM)	2000V

1. Driven the arrays at higher currents, however lumen maintenance may be reduced.
2. Proper current derating must be observed to maintain junction temperature below the maximum.
3. Pulsed operation with a peak drive current equal to the stated peak pulsed forward current is acceptable if the pulse time is $\leq 1\text{ms}$ per cycle and the duty cycle is $\leq 10\%$.

PRODUCT NOMENCLATURE

ARPL-37W-TFA-1919-Day4000-90

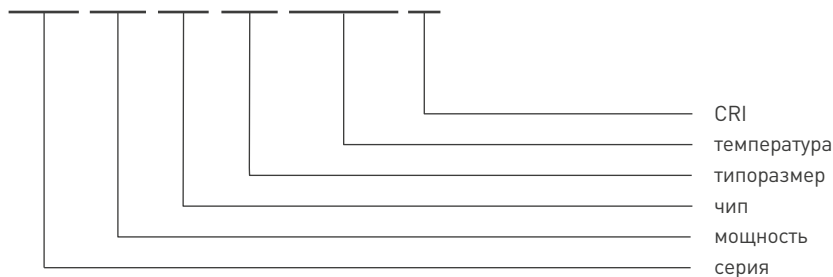

Артикул	Наименование	Примечание
036076	Мощный светодиод ARPL-37W-TFA-1919-Warm3000-90	Мощный светодиод типа COB, размер 19×19 мм. Цвет свечения теплый (3000 K). Угол излучения 120°. Световой поток 4271-4649 лм при If=1080 мА, P=37.8 Вт. VF=35 В. CRI>90.
036077	Мощный светодиод ARPL-37W-TFA-1919-Day4000-90	Мощный светодиод типа COB, размер 19×19 мм. Цвет свечения дневной (4000 K). Угол излучения 120°. Световой поток 4628-5006 лм при If=1080 мА, P=37.8 Вт. VF=35 В. CRI>90.
036078	Мощный светодиод ARPL-37W-TFA-1919-White6500-90	Мощный светодиод типа COB, размер 19×19 мм. Цвет свечения белый (6500 K). Угол излучения 120°. Световой поток 4539-4917 лм при If=1080 мА, P=37.8 Вт. VF=35 В. CRI>90.

CHROMATICITY COORDINATE GROUPS

Graph of Test Bins in xy Color Space (Pulsed Test Conditions, $T_C=25^\circ\text{C}$)

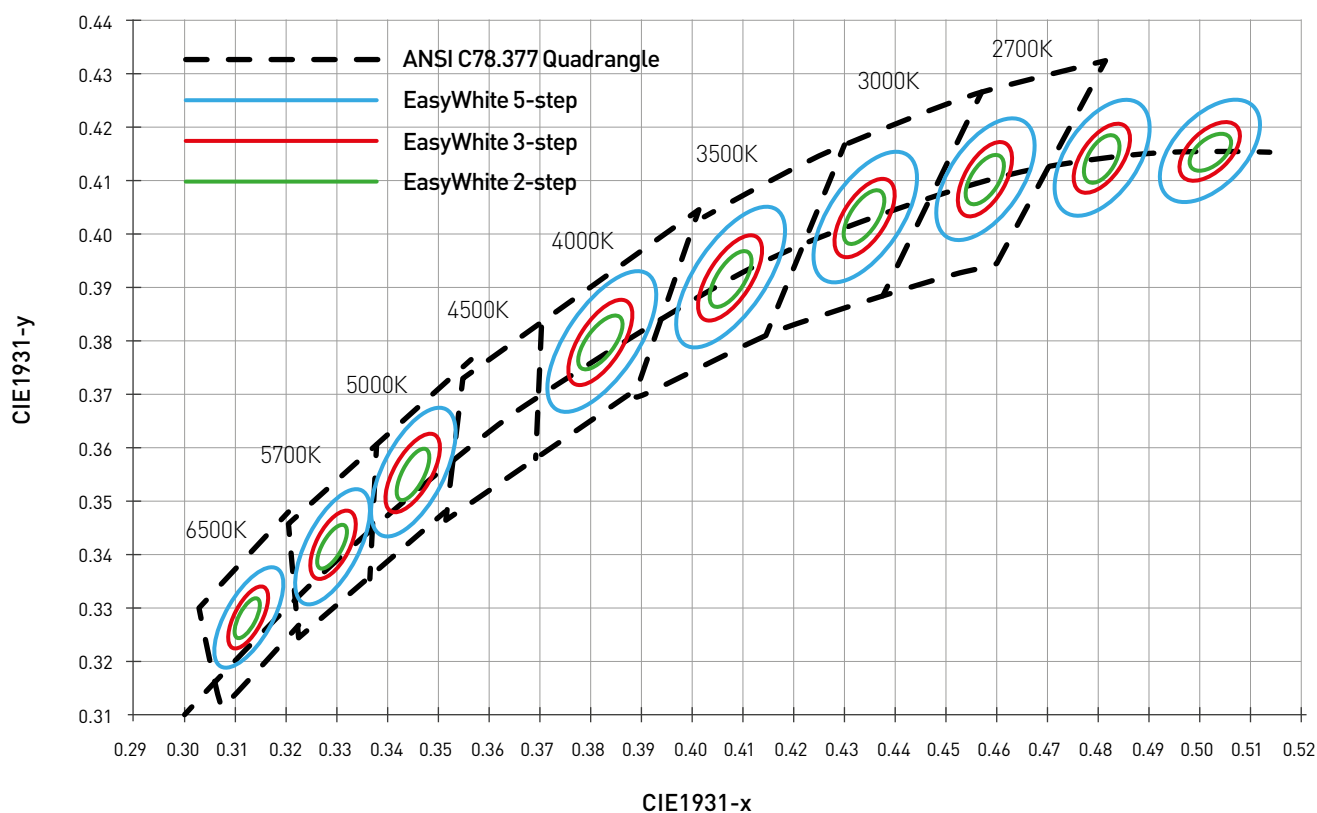

Nominal CCT	Center Point		MAJOR AXIS (a , b)			Ellipse Rotation Angel, θ
	X	Y	2-Step	3-Step	5-Step	
3000 K	0.4338	0.4030	(0.0057, 0.0028)	(0.0086, 0.0042)	(0.0142, 0.0069)	53.7
4000 K	0.3818	0.3797	(0.0063, 0.0027)	(0.0093, 0.0042)	(0.0157, 0.0068)	53.4
6500 K	0.3290	0.3417	(0.0048, 0.0021)	(0.0072, 0.0032)	(0.0119, 0.0052)	58.8

In the CIE 1931 color space, the product maintains a tolerance of ± 0.005 on the x and y coordinates.

CHARACTERISTIC CURVES

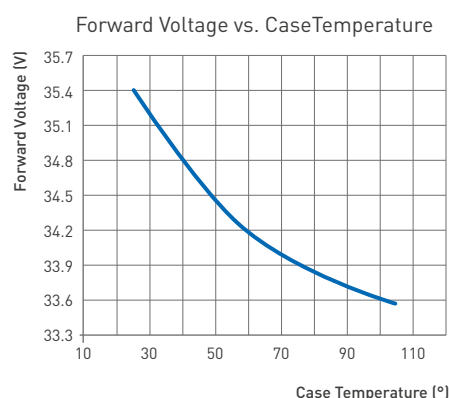
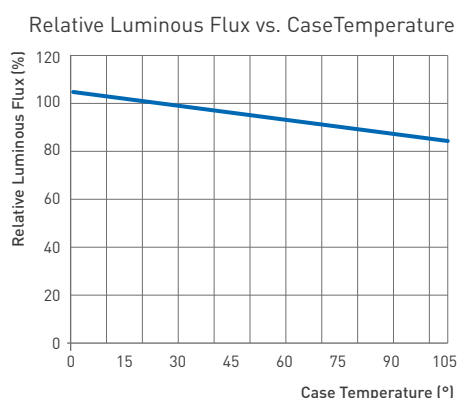
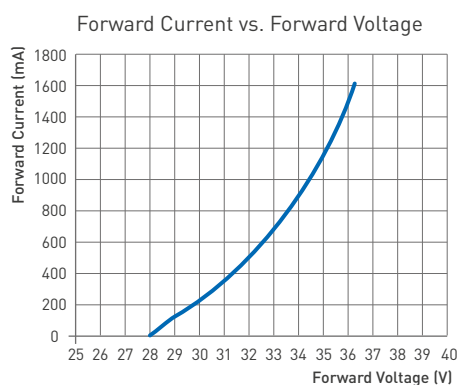
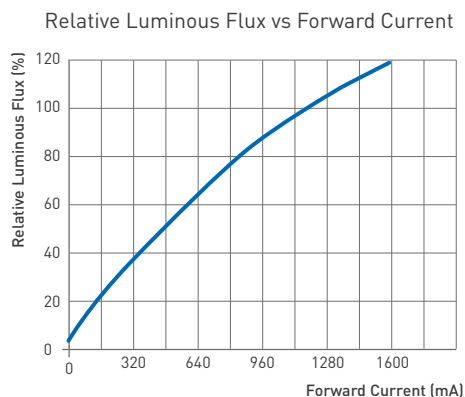

1. TYF does not recommend driving our LED arrays at high currents. Doing so may produce unpredictable results.
2. Products tested based on operation under DC and installed on a heat sink with thermal interface material to ensure T_j (junction temperature) = 25 °C. Based on the establishment of the same party test device, the measured value also depends due to the thermal design conditions of the lamp and the exposed ambient temperature and other conditions.

OPTICAL CURVES

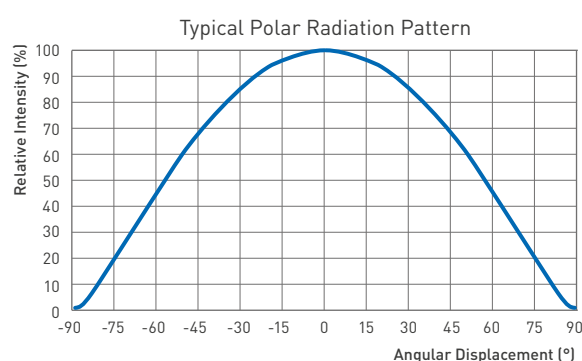
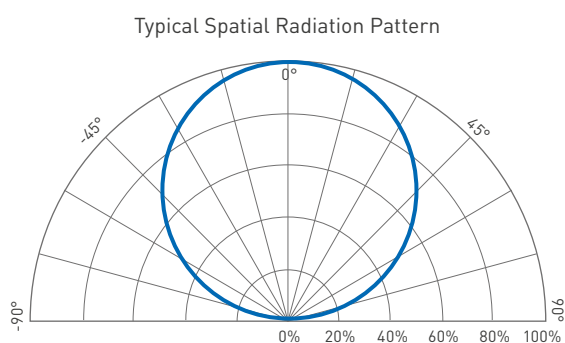

Typical viewing angle is 120°. The viewing angle is defined as the off axis angle from the center line where intensity is 1/2 of the peak value.

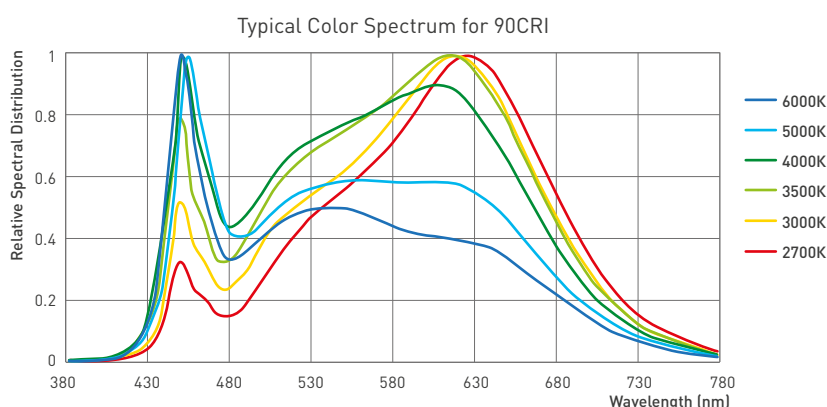

1. Color spectra measured at nominal current for $T_j = T_c = 25^\circ\text{C}$.
2. Color spectra shown is 2700K and 6000K with CRI90.

RELIABILITY TEST

Test Item	REF. Standard	Test condition	Sample quantity	Failure quantity
Thermal Shock	JESD22-A106	-40 °C (15min) ~ 100 °C (15min), 200 cycles	22	0
High Temperature Storage	JESD22-A103	Ta=120 °C, 1000h	22	0
Low Temperature Storage	JESD22-A119	Ta=-40 °C, 1000h	22	0
High Temperature High Humidity Life Test	JESD22-A101	Ta=85 °C, RH>=85%, 1000h	22	0
High Temperature Life Test	JESD22-A108	Ta=105 °C, IF=1080mA@1 pcs 1000h	22	0
Low Temperature Life Test	JESD22-A108	Ta=-40 °C, IF=1080mA@1 pcs 1000h	22	0